

Anfrage

Bestellung

Datum:

Firmenstempel / -Anschrift

Ansprechpartner:

Telefon:

Kommission:

Unterschrift:

Ansicht von Aussen / 2 Bahnen

(Evtl. Grundriss oder Ansicht mitsenden)

Typ 02/02 R

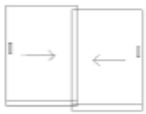

Typ 02/04 R

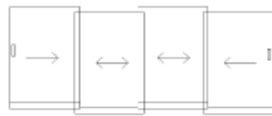

Typ 02/04 SI

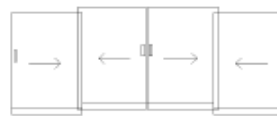

Eigene Variante

*Gem. Skizze auf der 3. Seite

Typ 02/02 L

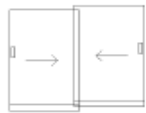

Typ 02/04 L

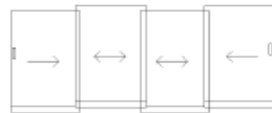

Typ 02/04 SA

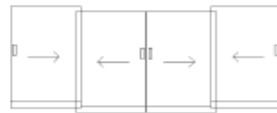

Ansicht von Aussen / 3 Bahnen

(Evtl. Grundriss oder Ansicht mitsenden)

Typ 03/03 R

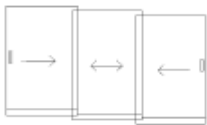

Typ 03/06 R

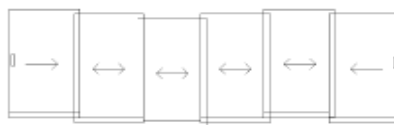

Typ 03/06 SI

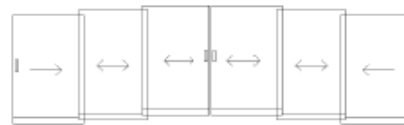

Eigene Variante

*Gem. Skizze auf der 3. Seite

Typ 03/03 L

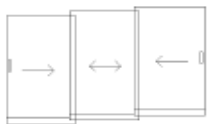

Typ 03/06 L

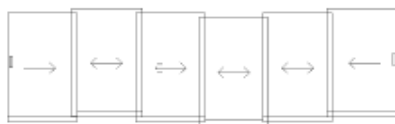

Typ 03/06 SA

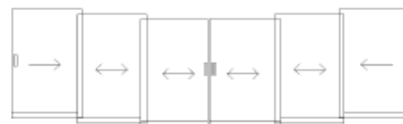

Ansicht von Aussen / 4 Bahnen

(Evtl. Grundriss oder Ansicht mitsenden)

Typ 04/04 R

Typ 04/08 R

Typ 04/08 SI

Eigene Variante

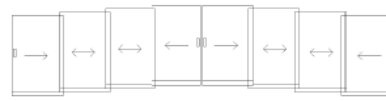
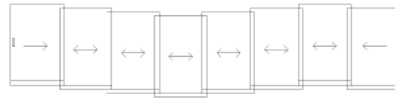
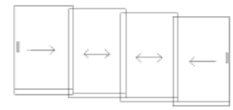

*Gem. Skizze auf der 3. Seite

Typ 04/04 L

Typ 04/08 L

Typ 04/08 SA

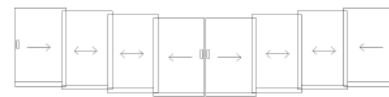
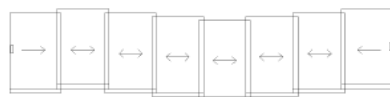
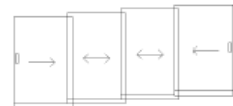

Anzahl _____

Abmessung: Kleinste Breite _____

Kleinste Höhe _____

Farbe: E6-EV1 farblos eloxiert
 RAL _____
 Andere _____

Verglasung 10 mm
 und Stärke: 12 mm

ESG Float klar
 Satinato farblos
 Satinato extraweiss mit Heat-Soak-Test

(Führungsschiene bleibt eloxiert)

Griffe, Schlosskasten und Zubehör:

seitr. Einlaufprofil

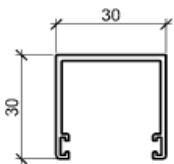

Staubschutzleiste
 50 mm Glasüberlappung

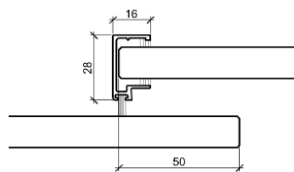

Dichtprofil für Stoss
 nur für 10 mm Glas

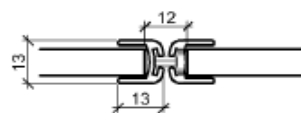

Mitnehmerprofil

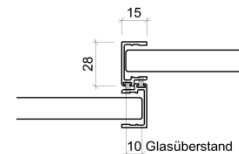

Führungsschiene ohne
 Wetterbank

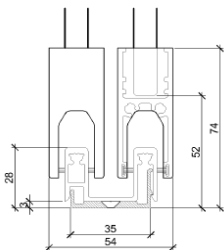

Führungsschiene mit
 Wetterbank in mm

100 150 200

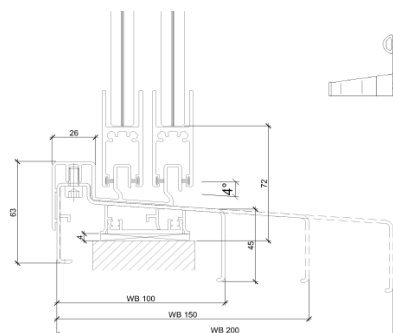

Glasschiebestopper

